

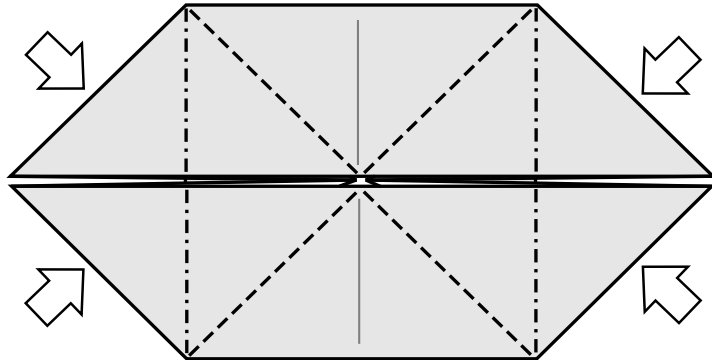

# Daylily

© B. Domangue 2013

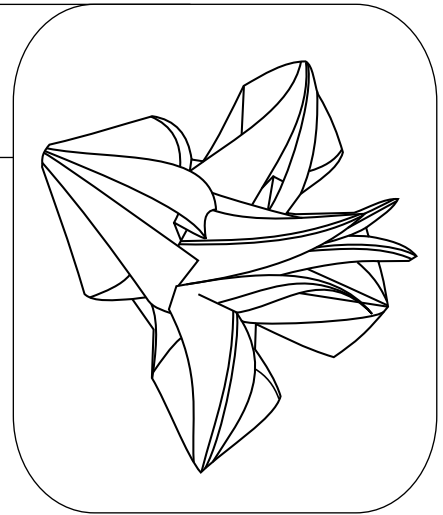

1. Begin with a boat base. Open and squash each flap.

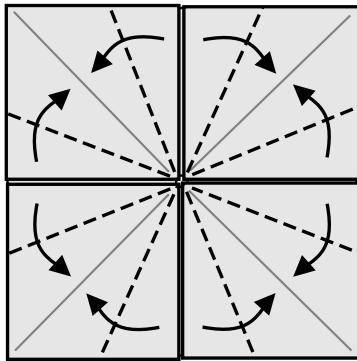

2. Valley fold.

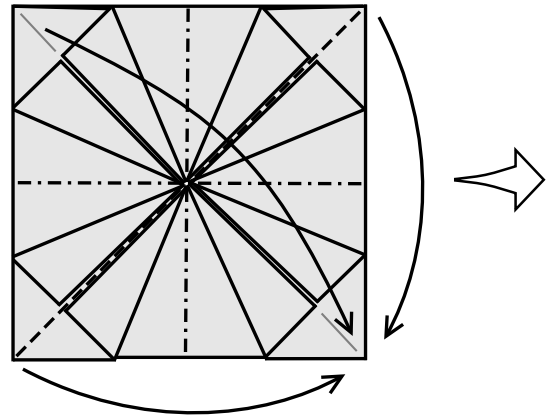

3. Collapse model (like a square base).  
Next step is enlarged.

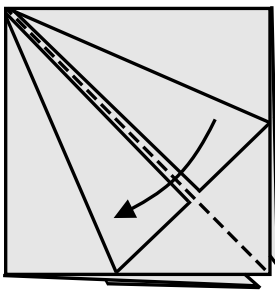

4. Valley fold.

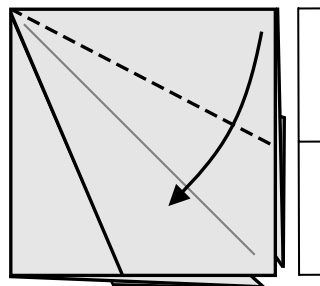

5. Valley fold.

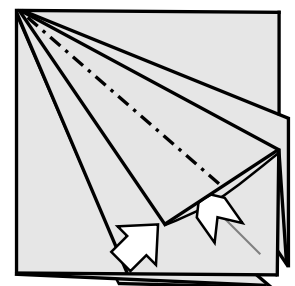

6. Open and squash.

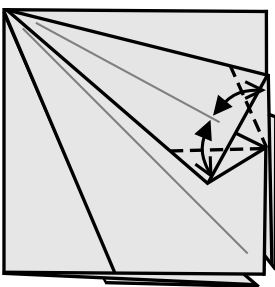

7. Valley fold to center and unfold.

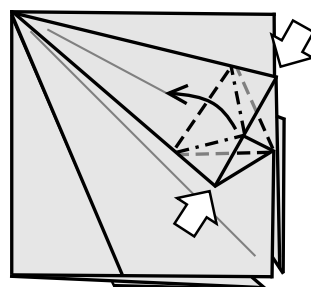

8. Petal fold.

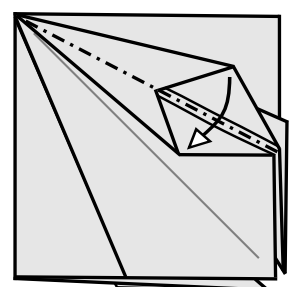

9. Mountain fold.

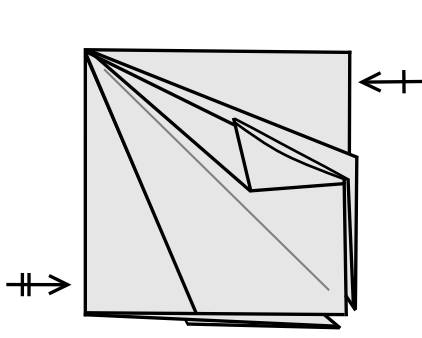

10. Repeat steps 4 - 9 on other three sides.

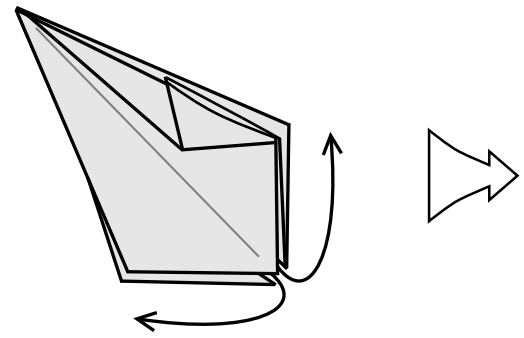

11. Unfold model to step 2. Next step is reduced.

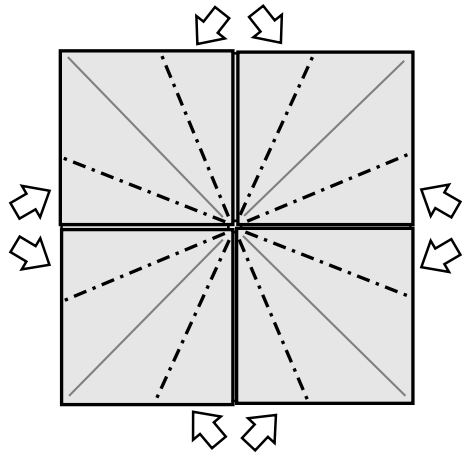

12. Inside reverse fold along existing creases.

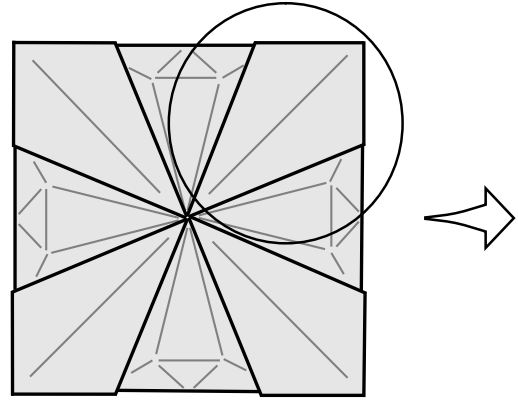

13. Next step is enlarged.

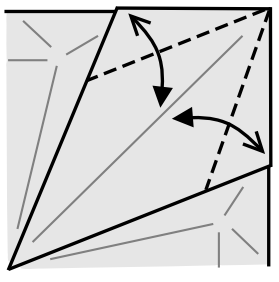

14. Valley fold and unfold.

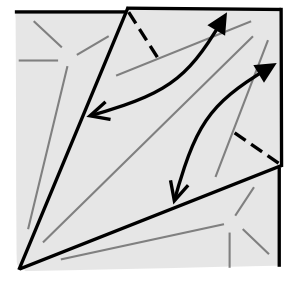

15. Valley fold edge to edge, then unfold.

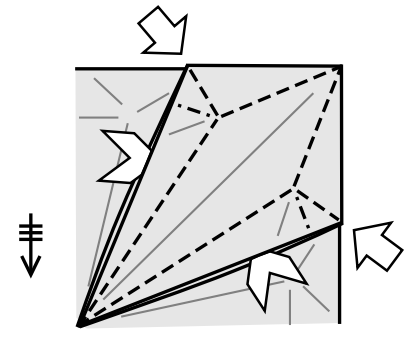

16. Begin to open, fold, and collapse model along creases.

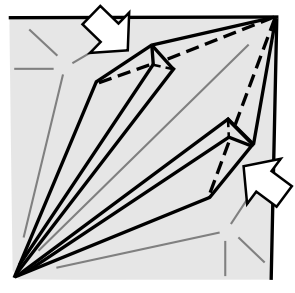

17. Intermediate step. Finish folding. Next step is reduced.

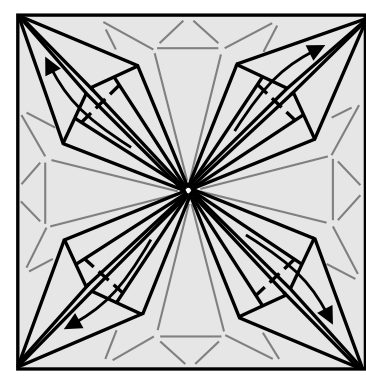
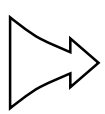

18. Valley fold narrow flaps to corners.

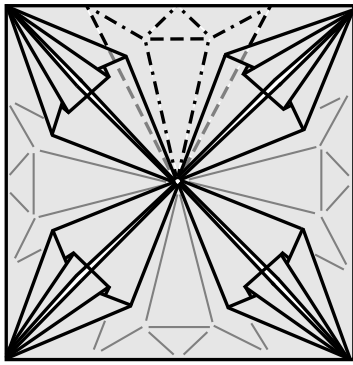

19. Re-fold petal fold from existing creases. Model begins to form a cup shape.

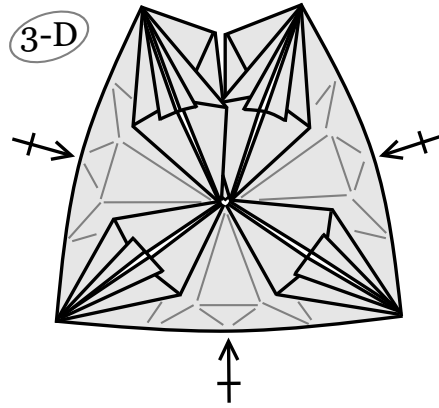

20. Repeat step 19 on other three sides.

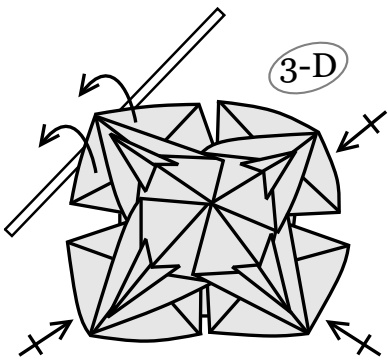

21. Curl petals outward.



22. Daylily complete.